

Article number: 20113044

Description: E+G

Side thrust pin GN 713-5-50-11,5-SB

## Measures

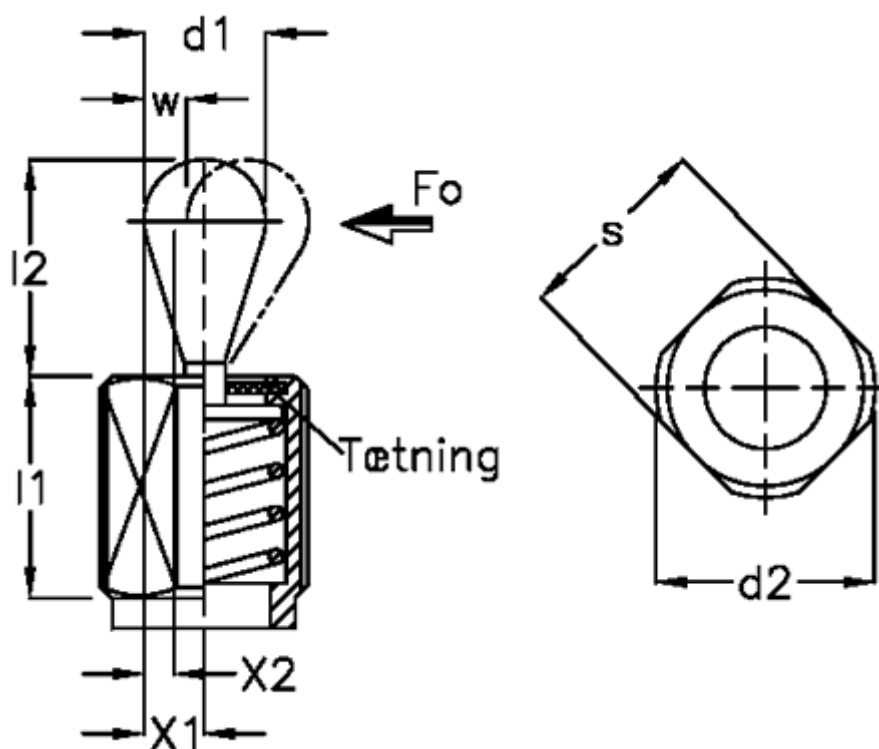

a1 = 2.5

a2 = 5.7

d1 = 5

d2 = M12

K = 1,5x45 degrees

l1 = 11.5

l2 = 6.7

l3 = 6

s = 3

screw driver = GN 713.1-5,6

Side power N at l2 = 50

W = 1.6

x1 = 1.7

x2 = 1.3